



# User Manual

100K/215kWh Energy Storage System









Chapter I System Introduction .....	4
1 Product introduction .....	4
1.1 Product introduction .....	4
1.2 Product appearance .....	4
1.3 Product parameter .....	4
Chapter II Product Composition .....	4
2 Battery Part .....	4
2.1 Battery system .....	4
2.2 Product parameter .....	4
2.3 Electrical schematic .....	5
2.4 Battery cluster composition .....	5
2.5 Battery system installation .....	7
2.6 Test run .....	7
3 Container Part .....	8
3.1 Container parameters .....	8
3.2 Open container inspection .....	8
3.3 Container transportation requirements .....	8
3.4 Precautions for safe use of the container .....	8
3.5 Precautions for safe use of electrical appliances .....	9
3.6 Precautions for safe use of entrances .....	9
3.7 Container accessories installation instructions .....	11
4 Fire Fighting Part .....	13
4.1 Product structure .....	13
4.2 Control logic .....	13
4.3 Working principle .....	13
5 Liquid Cooling Unit .....	13
5.1 Product description .....	13
5.2 Installation instructions .....	15
6 PCS .....	17
6.1 User instructions .....	17
6.2 System introduction .....	17
6.3 Use instructions .....	18
6.4 Precautions during operation .....	18
7 Maintenance and Troubleshooting .....	21
7.1 Instruction .....	21
7.2 Safety precautions .....	21
7.3 Troubleshooting .....	23
8 Storage and Emergency Response .....	24
8.1 Storage .....	24
8.2 Precautions .....	24
8.3 Precautions .....	25
9 Power Station Fault Handling and Emergency Plan .....	25
9.1 Power station fault handling .....	25
9.2 Power station emergency plan .....	28

### Symbol description

In order to ensure the personal and property safety of users when using this product and the efficient use of this product, the manual provides relevant safe operation information and highlights it with appropriate symbols.

The symbols used in this manual are listed below on Table 1-1. Please read them carefully.

Table 1-1 symbol description

	<p>Caution, there is a risk of electric shock.</p>
	<p>Do not place or install near inflammable and explosive materials.</p>
	<p>Please read the instruction manual before starting installation and operation.</p>
	<p>Hazardous waste.</p>
	<p>Recyclable</p>
	<p>Disconnect equipment before performing maintenance or repairs.</p>
	<p>Handling precautions must be observed when handling equipment susceptible to electrostatic discharge.</p>
	<p>Note that there is a danger of electric shock, and the stored energy is discharged regularly.</p>

## Chapter I System Introduction

### 1 Product Introduction

#### 1.1 Product introduction

Energy Storage System (ESS) is energy storage, which refers to the storage of a form of energy in the same form or converted into another form of energy through a medium or equipment, and it's a cyclic process that needs to be released in a specific form of energy based on future application requirement. The energy storage system is an important part of the "generating-transmission-transformation-distribution-utilization" link of the power grid, and an indispensable part of the energy Internet and smart energy.

SUNNYGROWs liquid cooling energy storage system uses lithium iron phosphate cells developed and produced by liquid cooling technology, and has the characteristics of strong reliability and high flexibility.

#### 1.2 Product appearance

Overall view of the container

#### 1.3 Product parameter

## Chapter II Product Composition

### 2 Battery Part

#### 2.1 Battery system

This product consists of 8 battery packs, 1 high voltage box and a set of battery brackets.

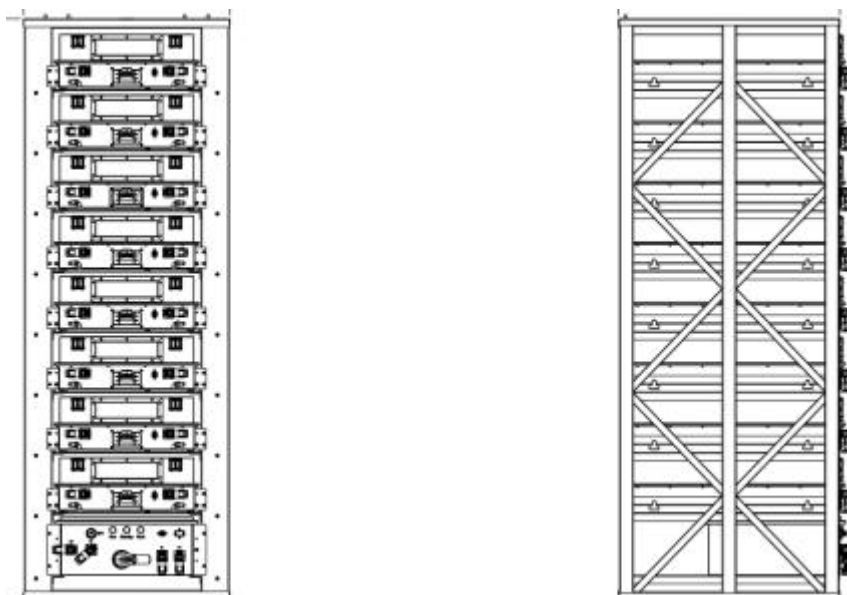

Schematic diagram of battery cluster

#### 2.2 Product parameter

2-1 Device parameter

Item	Parameter	Note
Composition	1P30S*8	1P240S

## Sunnygrow Liquid Cooling Energy Storage System User Manual

Item	Parameter	Note
Dimension (W*D*H) mm	888*952*2498	
Rated voltage V	768	
Nominal current Ah	280	
Nominal capacity kWh	215.04	
Operating Voltage V	732 V~ 876 V	3.05V~3.65V
Maximum continuous current	0.5C	

### 2.3 Electrical schematic

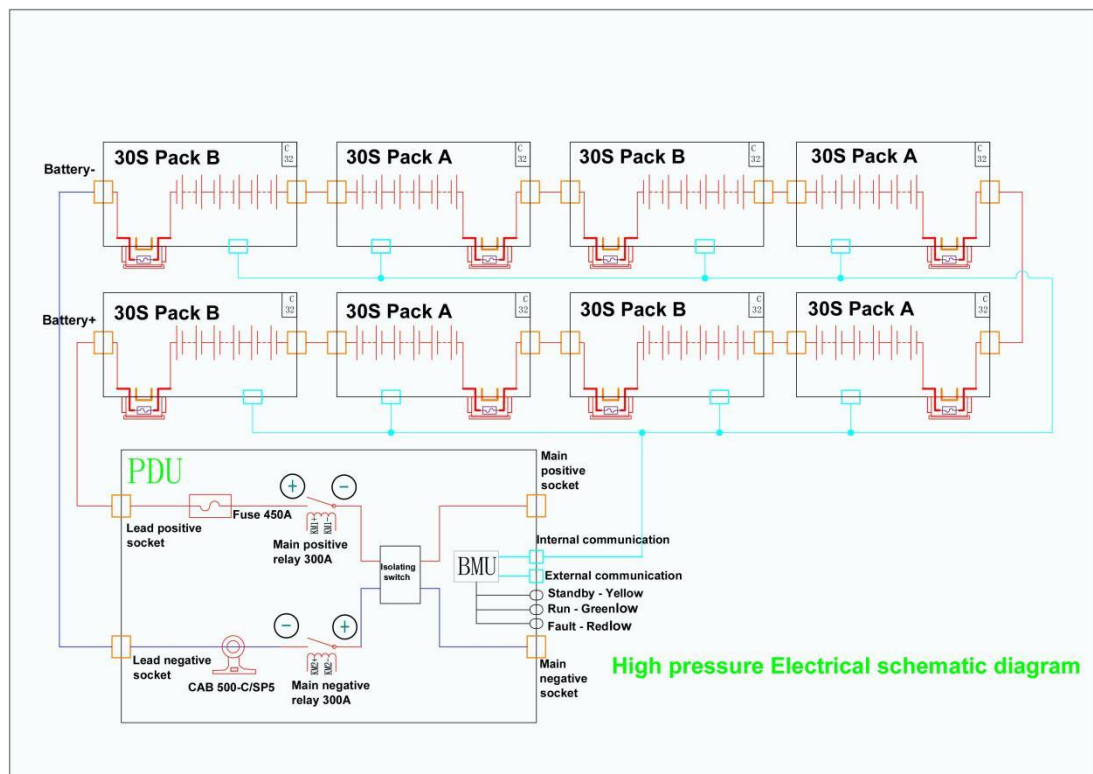

### 2.4 Battery cluster composition

#### 2.4.1 Battery unit

##### 2.4.1.1 Battery cluster

1. Battery bracket
2. Battery box
3. High pressure box

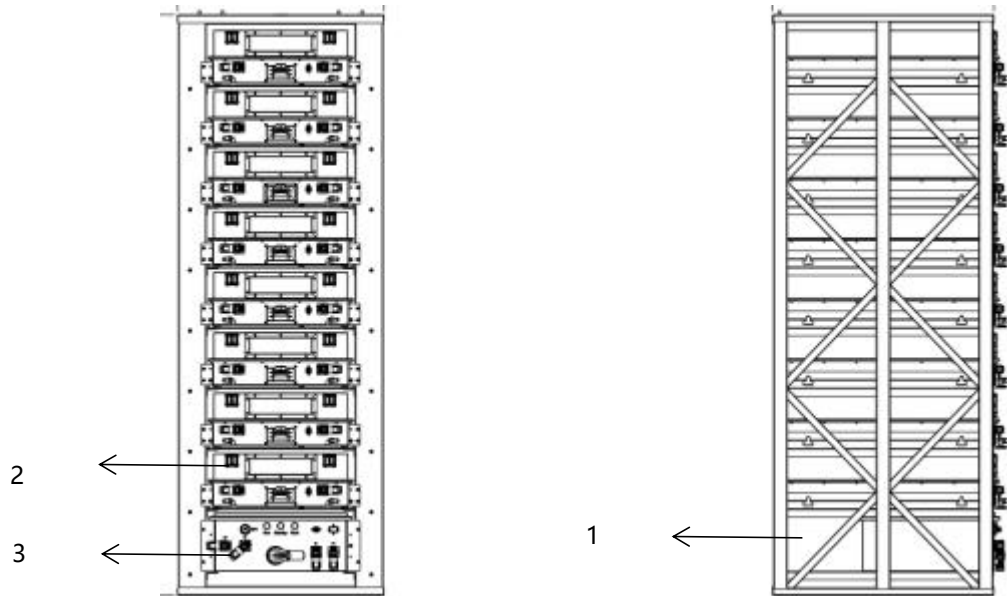

Schematic diagram of battery cluster

2.4.1.2 Battery box

1. Coolant inlet
2. Coolant outlet
3. Battery “-”
4. Battery “+”
5. Internal communication port

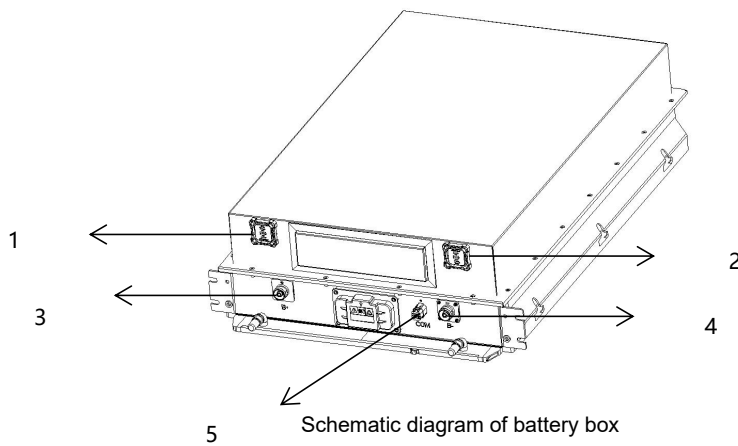

Schematic diagram of battery box

2.4.1.3 High pressure box

1. Internal communication port
2. External communication port
3. Battery “+”
4. Battery “-”
5. PCS“+”
6. PCS“-”
7. Breaker

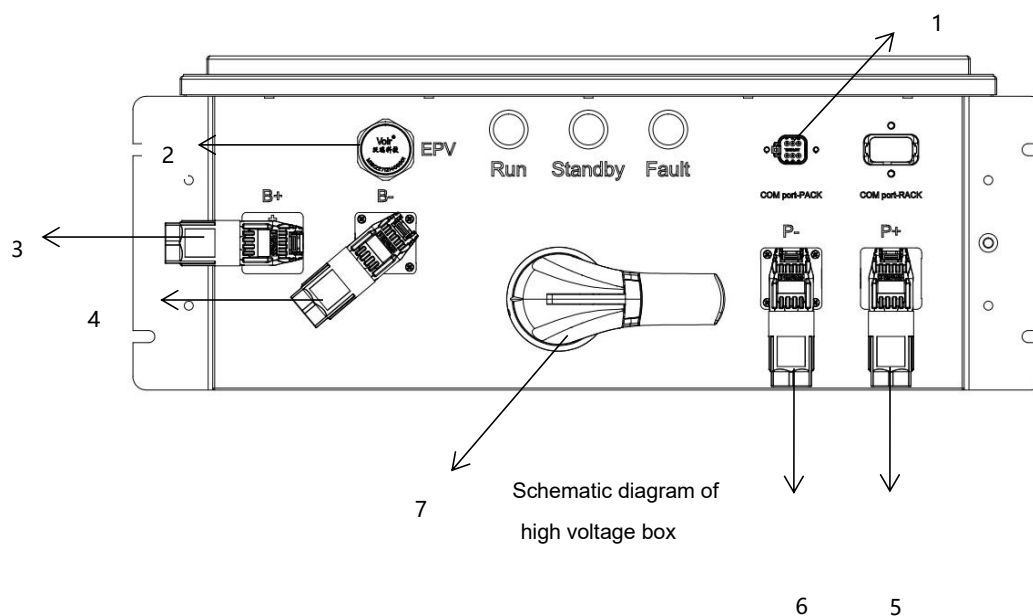

## 2.5 Battery system installation

Any work on the battery should be performed by an authorized technician, so the technician should be familiar with the contents of this manual before any maintenance or installation of the system is performed.

### 2.5.1 Installation Precautions

- ※ Please check the product for damage and missing parts after unpacking.
- ※ Before starting the installation, make sure the system is completely shut down.
- ※ Do not interchange the positive and negative poles of the battery.
- ※ Make sure that the terminals and external devices are not short-circuited.
- ※ Do not exceed the battery rated voltage of the PCS.
- ※ Do not connect the battery to any incompatible PCS.
- ※ Do not connect batteries of different types together.
- ※ Make sure the system is properly grounded.
- ※ Do not repair or disassemble the battery without permission.
- ※ In case of fire, use a dry powder fire extinguisher. Liquid fire extinguishers should not be used.
- ※ Do not install the battery near water or where the battery will get wet.
- ※ The battery should be installed away from children or pets.
- ※ Do not use the battery in a high static environment to avoid damaging the protective device.
- ※ Do not install with other batteries or cells.

## 2.6 Test run

Note: Debugging and trial operation must be carried out by qualified personnel

### 2.6.1 Check before starting

Before trial operation, thoroughly check the installation of the equipment, and especially check whether the power wiring harness and the communication wiring harness are in compliance with the requirements. And the system is well grounded. Grounding resistance is of great significance to the safety of the entire system, and it must be determined that the grounding resistance meets the requirements before the first trial operation.

The energy storage system circuit breaker is open.

### 2.6.2 Start-up operation process

- (1) When the circuit breaker is closed, the device starts self-checking.

(2) Confirm the communication of the energy storage system on the PCS or BAU end. When the PCS or BAU end shows that the device is normal, the charging and discharging actions can be performed. When the energy storage system performs charging and discharging actions, the "running indicator" (green) lights up. For the operation on the PCS side, please refer to the PCS operating procedures.

(3) When the energy storage device has a serious failure, the "fault indicator" (red) lights up;

(4) For the operation on the PCS side, please refer to the PCS operating procedures.

### 2.6.3 Shutdown operation process

When equipment maintenance needs to shut down the energy storage system, first reduce the power on the PCS side to "0kW", and then close the circuit breaker. The circuit breaker can also be turned off directly in an emergency.

## 3 Container Part

In order to ensure the safe and standardized use of customized equipment containers, and to safeguard the public interests of both parties, please read the "Container User Manual" carefully.

### 3.1 Container parameters:

Container length: 2991mm

Container width: 2438mm

Container height: 2896mm

Please refer to the confirmed drawings for specific container specifications.

### 3.2 Open container inspection

When opening the container for the first time, please follow the packing list and pay attention to check the packing materials in the container;

### 3.3 Container transportation requirements:

1. The size of the container is the same as the standard 10HC container. The container transport trailer should be suitable for the size of the container. It is not recommended that the container be suspended outside the trailer.
2. In order to prevent damage to the customized container from excessive speed/bumps, please ensure that the speed does not exceed 70 km/h on better surfaces such as highways, and the speed of unrepaired roads such as dirt roads shall not exceed 30 km/h.
3. When fixing the container with the trailer, attention must be paid to the protection of the container. Do not use wire ropes or other dirty binding materials to contact the container. Contact with the container requires thick cardboard or baled cotton to prevent paint damage.
4. After the container arrives at the customer's site, please take a look around the container to see if there is any damage. If there is any damage, please make a note on the equipment handover list, and send the photos back to our company.

### 3.4 Precautions for safe use of the container

1. The stacking height of the container shall be in accordance with the requirements of the marking, and the frame & main structure shall not be altered without authorization.
2. The ground or fixed point on which the box is installed and parked must be level and firm.
3. The foundation needs to be compatible with the box, including but not limited to load bearing, size, installation point and foundation flatness.
4. Ensure personal safety during lifting and handling;
5. The proposed lifting scheme is as follows (Figure 1):



Select a proper crane and wire rope according to the actual weight of the container.

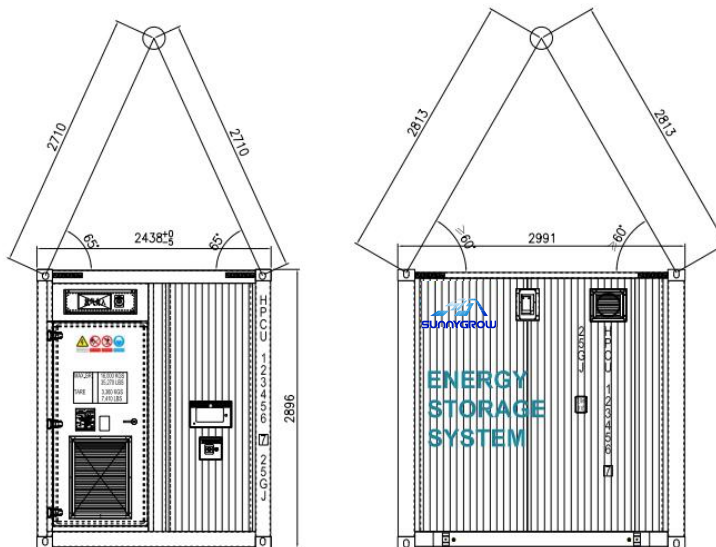

Hoisting method: Hoisting from the top corner piece, the maximum lifting weight is less than 10T

Lifting instructions:

1. Container size: 2991mm×2438mm×2896mm;
2. When hoisting, please confirm that there is no obstacle around, slowly and steadily hoisting, to ensure hoisting safety;
3. Do not scratch the container paint when installing the lifting wire rope;

### 3.5 Precautions for safe use of electrical appliances

1. Non-professionals are not allowed to change the distribution box and indoor wiring without authorization; If you really need to change the line, please contact our electrical engineer in order to provide supporting services.
2. Must be grounded before use. The grounding position of the container is as follows (Figure 2):

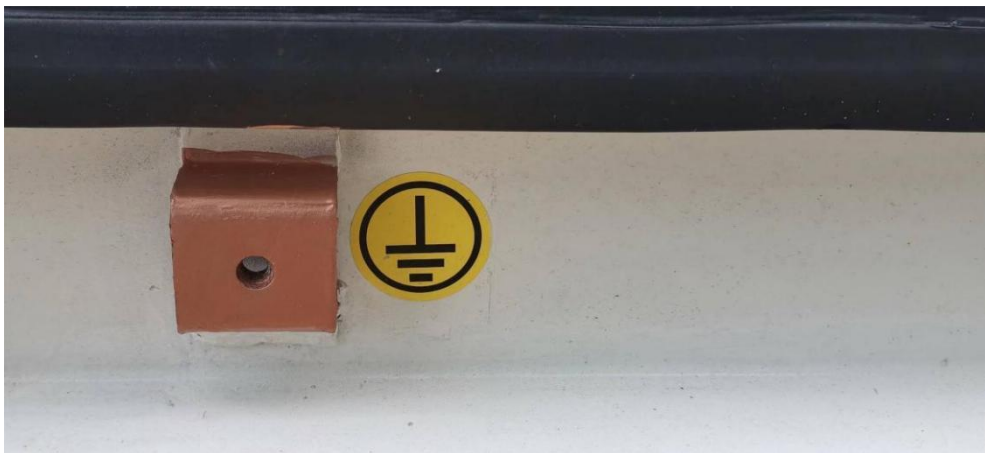

Container grounding base

3. The electrical appliances in the container should be used under the guidance of the instructions. Do not let the appliance get wet or damp, and avoid damage to the electrical appliance and risk of electric shock.
4. When the insulation or casing of the electrical device is damaged, which may cause the human body to touch the live part, stop using it immediately and have it repaired or replaced by a professional.
5. For the electrical schematic diagram of the container, please refer to the appendix.

### 3.6 Precautions for safe use of entrances

1. The large lock-rod door of the container is only used for installation and maintenance equipment, and the internal push-rod door is the entrance and exit of normal personnel.

## Sunnygrow Liquid Cooling Energy Storage System User Manual

2. When opening and closing the entrance door, strong pulling and pushing are strictly prohibited. Do not disassemble and assemble at will, so as not to damage the parts.
3. Do not hang heavy objects on the door.
4. When people enter and exit the container, please close the door to prevent the entry of rainwater. If the door cannot be closed under special circumstances, please use the door hook under the door to fix it to avoid accidental closing and injury. (Figure 3)



5. Incoming maintenance personnel need to clearly know the escape route and exit signs. (Figure 4)



Escape door push rod lock

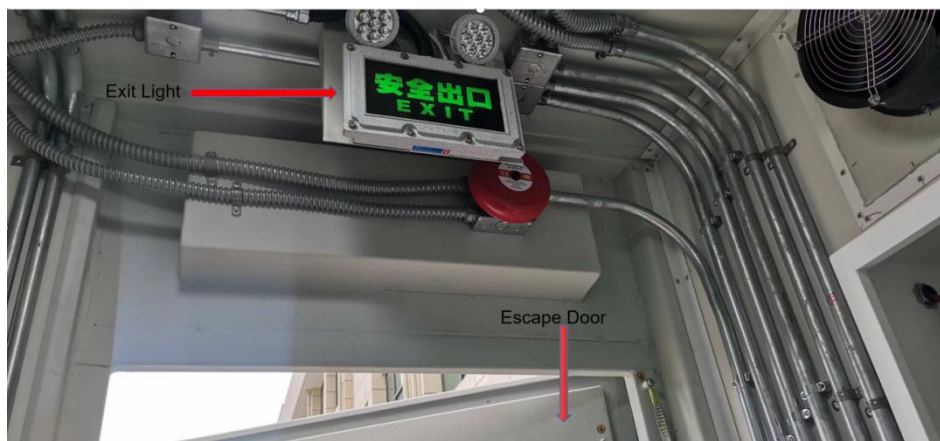

Exit light

### 3.7 Container accessories installation instructions

Installation steps of the hood:

1. Place the hood in the corresponding position of the container and align with the holes;
2. Fix the hood to the container with bolts;
3. Apply sealant to the periphery of the hood installation surface and the installation bolts;

Note: Before installation, make sure to check that the EPDM has been pasted around the installation edge of the hood! (Figure 5)

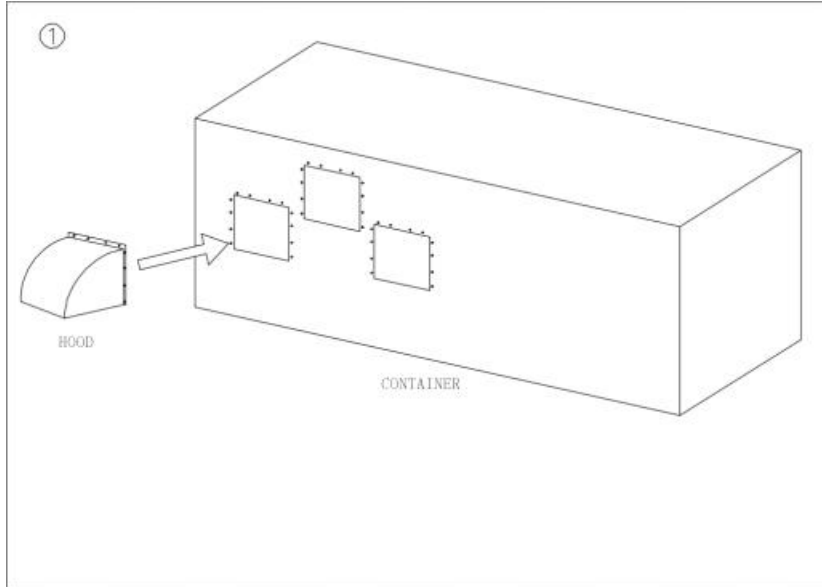

## 4 Fire Fighting Part

### 4.1 Product structure

The fire fighting part consists of gas fire extinguishing controller, deflation indicator light, emergency release and manual switch, emergency stop button, smoke detector, temperature detector, sound alarm, sound and light alarm, relay, automatic pressure relief device, H2 detector, exhaust fan and other components.

### 4.2 Control logic

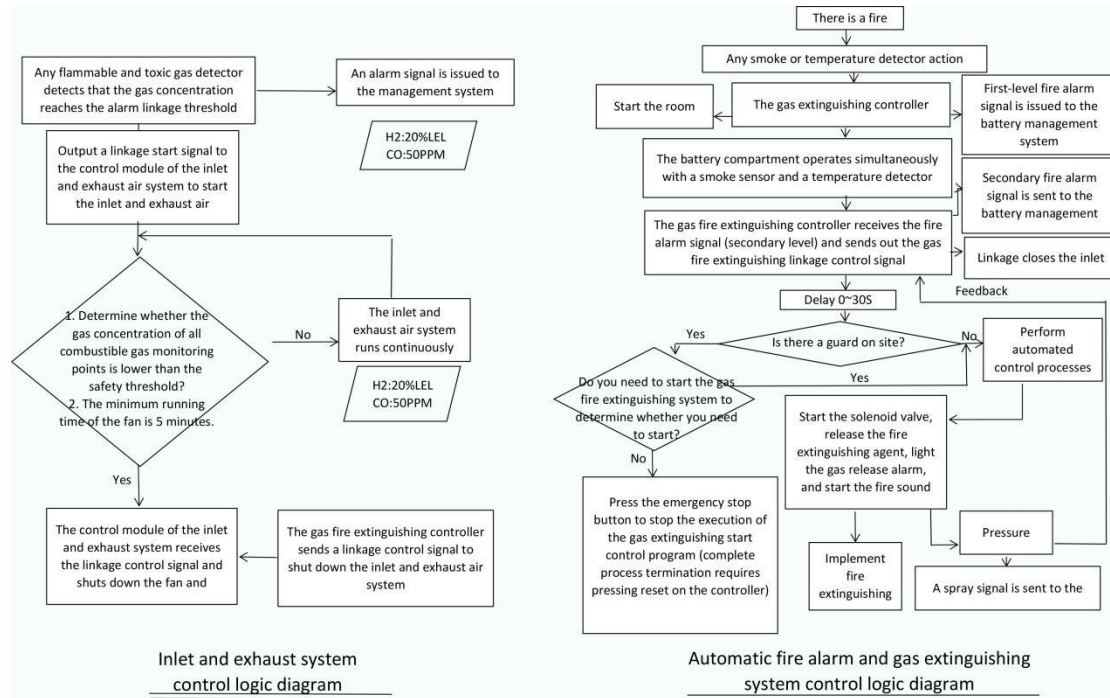

### 4.3 Working principle

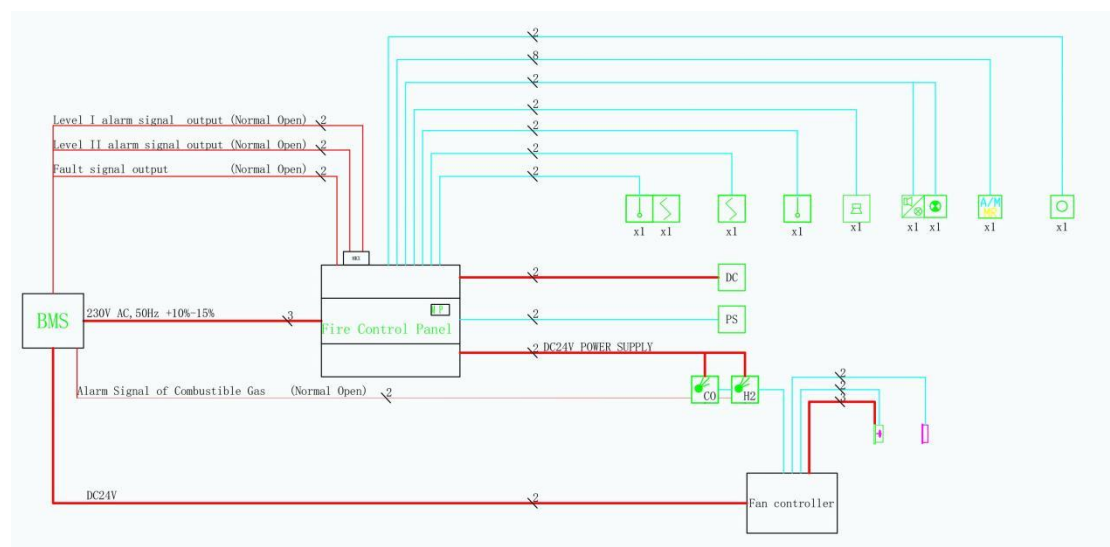

For details, please find the fire fighting system manual

## 5 Liquid Cooling Unit

### 5.1 Product description

#### 5.1.1 Characteristic

EMW75HDNC1A integrated air cooled water chiller is a refrigeration product that integrates an indoor unit and an outdoor unit. Mainly used in industries such as industrial cooling and energy storage heat dissipation, providing centralized and economical cooling functions. EMW75HDNC1A integrated air cooled water chiller mainly have the following characteristics:

### Advanced design:

The design structure of separate warehouses is adopted, and the pipelines are separated. It is easy to install and maintain and has the advantages of high flow, low temperature difference and thin thickness.

The shape is compact and the size is 1230×300×1400mm (W×D×H).

### Fully functional:

It integrates functions such as host computer communication, display operation and alarm, with high reliability, simple and convenient installation, and no need for complex debugging.

The Envicool high-efficiency controller is used to better adapt to unattended applications such as grid energy storage and small base stations.

### 5.1.2 Composition structure

EMW75HDNC1A integrated air cooled water chiller consists of seven parts: internal circulation water pump, external circulation fan, compressor, plate heat ex-changer, condenser, electronic expansion valve and control module.

Internal circulation water pump: Transport cooling medium.

External circulation fan: Exchange with outside air.

Compressor: Powers the refrigeration system.

Plate heat ex-changer: Absorbs heat from the outside environment and reduces the temperature of the outside environment.

Condenser: The high temperature gaseous refrigerant is liquefied and the heat is transferred to the external environment.

Electronic expansion valve: The supply of refrigerant injected into the plate heat exchanger is adjusted in real time.

Control module: Responsible for monitoring and maintaining the refrigeration system, providing a visual human-computer interface to ensure the normal operation of the system.

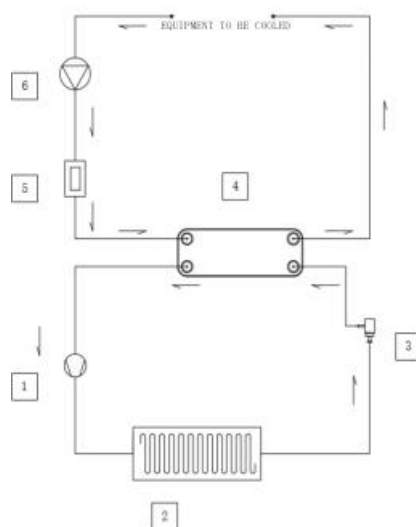

5.1.3 Working principle

(1) compressor

(2) condenser

- (3) electronic expansion valve
- (4) plate heat exchanger
- (5) electric heating tube
- (6) internal circulating water pump

The work process of EMW75HDNC1A integrated air cooled water chiller is as follows

The compressor (No. 1) compresses the gaseous refrigerant.

After the refrigerant is compressed, its temperature is higher than the temperature of the surrounding air.

According to the outlet water temperature or the demand issued by the host computer, the chiller system adjusts the load-related speed of the compressor motor through the DC frequency conversion technology, so as to realize the control of the power of the whole machine and the outlet water temperature.

The condenser (No. 2) condenses the high temperature gaseous refrigerant.

After the gaseous refrigerant is condensed, the heat is dissipated into the surrounding air through the surface of the condenser, and the state changes from gas to liquid.

The electronic expansion valve (No. 3) injects the condensed refrigerant into the plate heat exchanger (No. 4). The refrigerant evaporates in the plate heat exchanger and absorbs the heat of the cooling medium.

The system transports the cooling medium to the equipment to be cooled through the internal circulating water pump (No. 6) for cooling.

A temperature sensor located at the water outlet is responsible for regulating the inlet temperature of the cooling medium. The internal circulating water pump is controlled by the frequency converter and has the ability to adjust the speed and the flow of the cooling medium.

### 5.1.4 Specification

Voltage level	200V ~ 240V, 50/60Hz (Support dual firewire input)
External circulation temperature	indoor: -30°C ~ +55°C; outdoor: -30°C ~ +55°C
Cooling medium	50%Glycol aqueous solution

## 5.2 Installation instructions

In order to achieve the designed performance of the chiller and maximize its service life, please refer to the recommendations provided by the manufacturer to reserve space for installation and maintenance, and install it in strict accordance with the equipment drawings.

### 4.2.1 Shipping and Handling

Each chiller has undergone strict inspection and testing before leaving the factory, and great care must be taken during transportation and handling to avoid damage to the control system and piping components.

Before unpacking, try to move the chiller as close as possible to the installation site.

During handling and placement, the chiller must be kept upright.

When handling the bare metal of the unit, it is forbidden to lift the power cord protection cover and the water inlet and outlet connectors, and it is not allowed to use them as a force-bearing support.

Figure 2-1 shows the location of the power cord protection cover and the water inlet and outlet connectors.

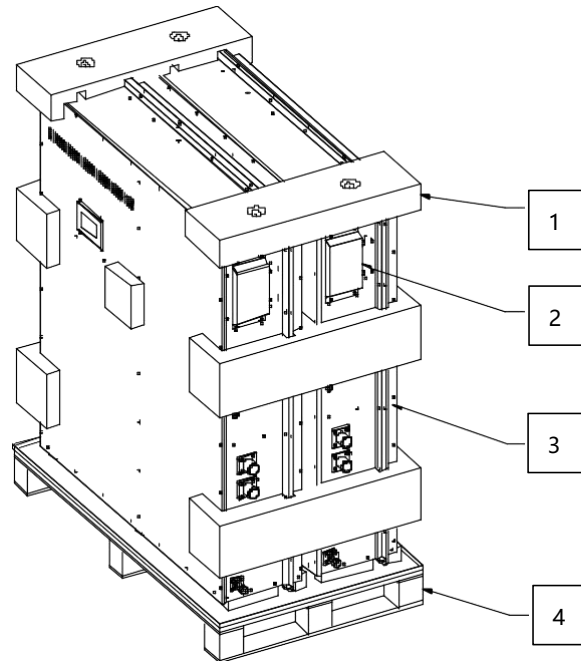

Figure 2-1 Location of the power cord protection cover and the water inlet and outlet connectors.

(1) cushion (2) cord protection cover (3) chiller (4) wooden pallet

### 5.2.2 Storage

Storage ambient temperature range:  $-40^{\circ}\text{C} \sim 70^{\circ}\text{C}$ .

Storage ambient humidity range: Relative humidity 5% ~ 95%.

When storing, the chiller (with packaging) must be kept upright, and it is strictly forbidden to place the chiller upside down or lie down.

### 4.2.3 Unpacking and inspection

When unpacking, check the chiller carefully for damage caused by transportation, especially for loose parts, dents, abrasions, and oil leaks. If any damage is found, please report it to the seller within one week with the bar code number on the outside of the package.

After removing the package, please make sure that the chiller is placed upright, and it is not allowed to lay it flat or upside down.

Please pay attention to the packing list and accessory bag inside the package.

Before handling the packaging material, make sure that the packaging material does not contain any loose or fallen parts. In order to protect the environment, it is recommended to recycle the packaging boxes (carton and wooden boxes).

If the product is not to be installed immediately, or if the product needs to be transported to another area, please repack the chiller after the unpacking inspection is completed.

### 5.2.4 Installation Environment

The equipment will make noise when it is running normally, please do not install the equipment in a place that will affect the working and living environment.

Before installation, make sure that the current installation environment meets the requirements, as follows:

Try to choose a spacious area as the installation site of the chiller.

When the chiller is installed in a narrow space, it will affect the airflow structure of the air, resulting in short circuit of the outdoor inlet & return air and air noise, which may eventually affect the normal operation of the chiller.

Avoid placing multiple chillers next to each other and install the vent opposite each other.



Multiple units are close to each other and the air vent are opposite, which will cause the airflow of the outdoor return air & the outlet air to cross between different units, affecting the cooling capacity of the chiller.

Avoid installing additional devices on the chiller.

Installing additional devices may interfere with routine maintenance and servicing of the chiller.

### 5.2.5 Installation method and space

The pipeline of the chiller has been assembled before leaving the factory, and the refrigerant has been charged and tested in accordance with the standard, and the installation site does not need to be charged with refrigerant.

The chiller adopts an integrated design, and components such as compressor, condenser, plate heat exchanger, throttling device, control module, internal circulation water pump, and external circulation fan are packaged as a whole.

The chiller is installed in an embedded way. In order to ensure the normal operation of the chiller, it is not allowed to place objects on the external circulation air outlet of the chiller to obstruct the flow of air.

### 5.2.6 Prepare install tools

For details, please find the liquid cooling system manual

## 6 PCS

### 6.1 User instructions

This manual is applicable to personnel who install and perform other work on this product. Readers need to have certain electrical, electrical wiring and mechanical expertise, familiar with electrical and mechanical schematics and characteristics of electronic components.

- ◆ Please read this manual carefully before using this product. Please store this manual and other data in the product components together, and ensure that relevant personnel can easily obtain and use it. In addition to this operation manual, the following documents are available for users at the same time: 《Installation Manual of Power Conversion System》
- ◆ This manual covers important information and data for the use of the product. Users must strictly abide by its provisions to ensure the normal operation of the product.
- ◆ The contents of the manual will be updated and revised continuously, but it is inevitable that there is a slight discrepancy with the real object. Users should take the purchased products as the standard, or ask for the latest version of the manual through the sales channel.

### 6.2 System introduction

This series of **power conversion system**, including transformers, provide an interface between the power grid and the battery, can effectively control the power resources, can well balance the difference of power consumption between day, night and different seasons, regulate the surplus, and ensure the safety of the power grid. When the power network is abnormal, the **power conversion system** can switch to the off-line mode to ensure stable power supply under emergency load.

The system with this series of power conversion system is shown in the following figure.

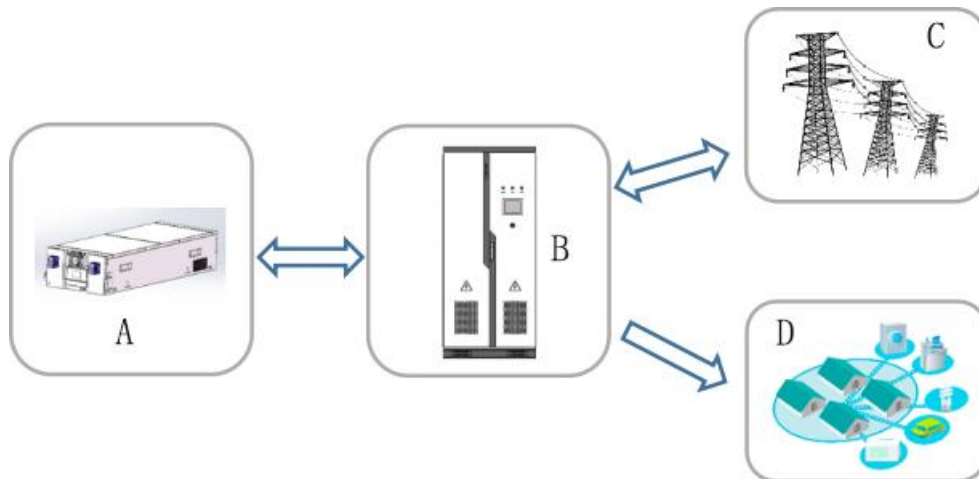

No.	Name	Explain
A	Storage battery pack	Lithium battery
B	Power conversion system	Energy conversion device between power grid and battery pack
C	Power grid	Three phase AC power grid
D	AC load	-

### 6.3 Use instructions

	<p><b>DANGER!</b></p> <p>Touching the contacts and terminals connected to the power grid or equipment may cause death by electric shock!</p> <ul style="list-style-type: none"> <li>Do not touch the terminals or conductors connected to the grid circuit.</li> </ul> <p>Pay attention to all instructions or safety instructions for connection to the grid.</p>
---	--

	<p><b>DANGER!</b></p> <p>Fatal high voltage exists inside the product!</p> <ul style="list-style-type: none"> <li>Pay attention to and observe the warning signs on the product.</li> <li>Observe the safety precautions listed in this manual and other relevant documents of the equipment.</li> </ul>
---	--

	<p><b>DANGER!</b></p> <p>Failure of damaged equipment or system may cause electric shock or fire!</p> <ul style="list-style-type: none"> <li>Preliminary visual inspection of the equipment for damage or other hazards before operation.</li> <li>Check whether other external equipment or circuit connections are safe.</li> <li>Confirm that the device is in a safe state before operation.</li> </ul>
---	---

### 6.4 Precautions during operation

#### 6.4.1 Manual storage

This manual contains important information for transportation and installation of the PCS. Please read this manual carefully before transportation and installation of the PCS.

- Please operate the bidirectional converter in strict accordance with the description in this manual, otherwise it may cause equipment damage, casualties and property loss.
- This manual shall be kept properly to ensure that transportation, installation and other operators can access it at any time.

### 6.4.2 Personnel requirements

- Only professional electricians or qualified personnel can carry out various operations on this product.
- The operator shall be fully familiar with the composition and working principle of the whole system.
- The operator shall be fully familiar with the 《installation manual》 and 《operation manual》 of the product.
- The operator shall be fully familiar with the relevant standards of the country / region where the project is located.

### 6.4.3 Machine identification protection

- The warning signs on the PCS body and in the cabinet contain important information for safe operation of PCS. It is strictly prohibited to tear or damage manually!
- The rear cover plate of PCS is equipped with a nameplate, which contains important parameter information related to the product. It is strictly prohibited to tear or damage manually!

	<p><b>ATTENTION</b></p> <ul style="list-style-type: none"><li>• Ensure that the body identification is clear and readable at all times.</li><li>• Once the body identification is damaged or blurred, it must be replaced immediately.</li></ul>
---	--

### 6.4.4 Setting of safety warning signs

During the installation, daily maintenance, overhaul and other operations of PCS, misoperation or accident shall be prevented to prevent irrelevant personnel from approaching. Please observe the following:

- Obvious signs shall be set up at the front and rear level switches of PCS to prevent accidents caused by false closing.
- Set up warning signs or safety warning belts near the operation area.
- After installation, be sure to pull out the cabinet door key and keep it properly.

### 6.4.5 Requirements for escape routes

In order to ensure that staff can leave the site quickly in case of accident, please observe the following:

- During the whole process of maintenance, overhaul and other operations of PCS, it is necessary to ensure that the escape passage is completely unblocked.
- It is strictly prohibited to stack sundries in the escape passage or occupy the escape passage in any form.

### 6.4.6 Device installation

The PCS must be installed exactly as described in this manual.

The PCS is designed with a ingress protection of IP20 and is suitable for indoor installation. In order to avoid the noise generated during the operation of the PCS and other possible emergencies that affect the normal life of residents or cause safety accidents, the PCS should be installed away from the living area of the residents.

### 6.4.7 Electrical connections

Electrical connections must be made in strict accordance with the descriptions in this manual and the electrical wiring schematics.

	<p><b>WARNING!</b></p> <ul style="list-style-type: none"><li>• Parameters such as current, voltage, and power on the DC side must meet the technical parameters of the PCS.</li><li>• The PCS can be connected to the grid side only after the approval of the local power supply company and the installation by professional technicians</li></ul>
---	--

	<p><b>WARNING!</b></p> <p>Please strictly follow the wiring identification inside the device to perform wiring operations.</p>
---	--

### 6.4.8 Use of measuring equipment

During the electrical connection and commissioning of PCS, relevant electrical measuring equipment is required to ensure that the electrical parameters meet the requirements.

	<p><b>WARNING!</b></p> <ul style="list-style-type: none"><li>• Select high-quality measuring equipment whose measuring range and usable conditions meet the on-site requirements.</li><li>• Ensure that the connection and use of measuring equipment are correct and standardized to avoid arc and other hazards.</li><li>• Do protective work in case of live measurement (such as wearing insulating gloves, etc.).</li></ul>
---	--

### 6.4.9 Complete power off operation

Perform operations on the PCS only when ensured that it is completely de-energized.

- Make sure that the PCS cannot be accidentally re-energized.
- Use a multi-meter to ensure that the inside of the PCS is completely de-energized.
- Make the necessary grounding and short-circuit connections.
- Use insulating cloth to insulate and cover the operating parts adjacent to potentially live parts.
- During the entire operation, it is necessary to ensure that the escape route is unobstructed.
- After the PCS is completely out of service, be sure to wait at least 15 minutes to ensure that the internal capacitors are fully discharged before operating the PCS.

6.4.10 Static protection, etc.

For details, please find the liquid cooling system manual

## 7 Maintenance and Troubleshooting

### 7.1 Instruction

Due to the influence of ambient temperature, humidity, dust and vibration, the devices inside the energy storage system will age, which will affect the performance of the system and even lead to malfunctions that cannot work properly.

Therefore, it is necessary to carry out routine and regular maintenance on the energy storage system to ensure its normal operation and service life. All measures and methods that help the energy storage system to be in good working condition belong to the category of maintenance work.

If a malfunction occurs and the problem cannot be solved with the help of this manual. Please contact us in time and send the following information in order to provide you with better service:

- ◆ Photos of the fault scene
- ◆ Device model and serial number.
- ◆ Other device parameters connected to the energy storage device
- ◆ Communication connection scheme of energy storage system.
- ◆ Fault information and brief description.

### 7.2 Safety precautions

#### 7.2.1 General safety

In order to ensure the safety of operators when maintaining or overhauling PCS, please observe the following safety rules:

- ◆ Disconnect the battery side circuit breaker of the PCS to ensure that the external connection between the energy storage system and the PCS is disconnected;
- ◆ Disconnect the external power supply and communication line of the energy storage system;
- ◆ Disconnect the circuit breaker of the energy storage system, disconnect the connection between the high-voltage box and the battery box, and the energy storage system goes offline;
- ◆ Ensure that the energy storage system is well grounded;
- ◆ Only qualified and authorized personnel should perform operations such as maintenance on the energy storage system. During maintenance, do not leave screws, gaskets and other metal parts inside the energy storage system to avoid damage to the energy storage system.

#### 7.2.2 Maintenance work

Maintenance items	Maintenance contents	Maintenance cycle
Energy storage system inspection	<ul style="list-style-type: none"> <li>◆ Observe whether the appearance of the energy storage system is damaged, deformed or rusted;</li> <li>◆ Listen whether there is any abnormal sound when the energy storage system is running;</li> <li>◆ Observe various parameters at runtime through PCS or BAU;</li> <li>◆ Use a thermal imager to detect the heating of the system;</li> <li>◆ Observe whether there is electrolyte leakage outside the battery box;</li> <li>◆ Check whether the ventilation, ambient temperature, humidity, dust and other environments around the energy storage meet the requirements.</li> </ul>	3 months
Air vent cleaning	<ul style="list-style-type: none"> <li>◆ Check the air vent dust.</li> <li>◆ Listen if there is abnormal vibration when the fan is running;</li> <li>◆ Use tools for cleaning.</li> </ul>	3 months
Circuit connection	<ul style="list-style-type: none"> <li>◆ Check all electrical connections for loose or poor contact</li> <li>◆ Check all cables and metal surfaces contacting skin for damage or scratches;</li> <li>◆ Check whether the insulating wrapping tape of all terminals is off;</li> <li>◆ Check the screw position for signs of overheating;</li> <li>◆ Check the wiring copper bars and screws for color changes.</li> </ul>	Half a year
Circuit breaker maintenance	<ul style="list-style-type: none"> <li>◆ Check all circuit breakers for failure;</li> <li>◆ Check the circuit breaker or load switch for damage.</li> </ul>	Half a year
Sign check	<ul style="list-style-type: none"> <li>◆ Check the body warning signs and other equipment signs;</li> <li>◆ If blurred or damaged, please replace it in time.</li> </ul>	A year

### 7.2.3 Operation and maintenance items

No.	Maintenance items
1	Check whether the safety door, main door and battery compartment door of the energy storage container can be opened normally
2	Check whether the internal and external environment of the energy storage container is clean, tidy, or has debris accumulated
3	Check whether the exterior of the energy storage container is corroded or peeled off
4	Check whether the fire-fighting equipment can alarm and start normally, and whether there is fire-fighting equipment around the energy storage container for quick use in the event of an accident
5	Check whether the insulation of each power line is normal, whether the electrical safety clearance meets the safety standard, and whether the connection bolts are loose
6	Check whether the electrical components are normal, and whether the main gate of each power source can be effectively disconnected
7	Check whether the grounding of the energy storage container is normal
8	Check whether the safety warning signs on the surface of the container have fallen off
9	Whether the battery cabinet and control cabinet in the container are firmly fixed
10	There should be no debris or other items accumulated in the inspection port in the container
11	Whether the blockage of the cable in and out of the equipment is in good condition
12	Whether the cable sheath is damaged
13	Check the cable open trench to prevent damage to the cable, and ensure that the bracket is grounded and the heat dissipation in the trench is good
14	The cable terminal joint is well grounded, the insulating sleeve is good, clean, and there is no trace of flashover discharge.

## 7.3 Troubleshooting

### 7.3.1 Troubleshooting

**WARNING:** Under fault conditions, fatal high voltages may still be present inside the energy storage system! Only qualified technicians should perform the operations described in this chapter. "Qualified technicians" means that the operator has previously participated in professional training on various operations of equipment troubleshooting. Only perform troubleshooting as described in this manual. When operating, follow all safe operating practices.

When the energy storage system cannot be charged and discharged abnormally as expected, please pay attention to the following items:

- ◆ Confirm that the fault information of the energy storage system is displayed on the PCS or BAU terminal;
- ◆ Confirm whether PCS or BAU is working properly;
- ◆ Whether the communication between the energy storage system and the PCS or BAU is normal;

### 7.3.2 LCD display failure and troubleshooting

Fault type	Troubleshooting
------------	-----------------

Monomer overvoltage	Shutdown, charging prohibited (The system judges by itself, and needs to be powered on again when a serious fault occurs)
Monomer undervoltage	Shutdown, discharging prohibited (The system judges by itself, and needs to be powered on again when a serious fault occurs)
Monomer voltage difference is too large	Shutdown, charging prohibited (The system judges by itself, and needs to be powered on again when a serious fault occurs)
Total voltage overvoltage	Shutdown, charging prohibited (The system judges by itself, and needs to be powered on again when a serious fault occurs)
Total voltage undervoltage	Shutdown, discharging prohibited (The system judges by itself, and needs to be powered on again when a serious fault occurs)
Battery high temperature	Shutdown, charging & discharging prohibited (The system judges by itself, and needs to be powered on again when a serious fault occurs)
Battery low temperature	Shutdown, charging & discharging prohibited (The system judges by itself, and needs to be powered on again when a serious fault occurs)
Battery temperature difference	Shutdown, charging & discharging prohibited (The system judges by itself, and needs to be powered on again when a serious fault occurs)
Low battery SOC	Standby, discharging prohibited (The system judges by itself)
Battery current is too high	Shutdown, discharging prohibited (The system judges by itself, and needs to be powered on again when a serious fault occurs)
BMS internal communication failure	Shutdown, check the communication line, acquisition unit and main control unit
Total positive and negative relay sticking	Shutdown, find cause of failure and replace damaged relay
Insulation alarm	Shutdown, find cause of failure and deal with poor insulation
Circuit breaker fails to close	Shutdown, check the circuit breaker's own fault or confirm whether the circuit breaker trips due to the total voltage undervoltage. Use external AC power supply. After the device works normally, use the internal power supply to cancel the external power supply.

## 8 Storage and Emergency Response

### 8.1 Storage

- (1) Storage temperature:- 10°C- 40°C (Optimum temperature: 0°C- 30°C );
- (2) Store in a dry, cool, air-ventilated surface with a relative humidity of less than 95%;
- (3) Keep away from fire, heat and corrosive substances;
- (4) Disconnect the emergency stop switch to ensure that the metal parts are not exposed to avoid short circuit;
- (5) After 3 months of storage, the battery status including voltage and temperature should be checked and the storage time should not exceed 6 months. It is recommended to charge and discharge the battery according to 0.3C.

### 8.2 Precautions

- (1) Do not expose batteries to open flames.
- (2) Do not place the product near flammable materials. In the event of an accident, fire or explosion may occur.



- (3) Store in a cool, dry and ventilated place.
- (4) Do not store product near water.
- (5) Place the product on a flat surface.
- (6) Product should be stored out of the reach of children and animals.
- (7) Do not drop, deform, hit, cut or penetrate the unit with sharp objects.
- (8) Electrolyte leakage or fire may result.
- (9) Do not touch any liquid spilled from this product. Danger of electric shock or skin damage.
- (10) Wear insulating gloves when working with batteries.
- (11) Do not step on the product or place any other objects. This may cause damage.
- (12) Do not charge or discharge damaged or abnormal batteries.

### 8.3 Precautions

The energy storage system consists of multiple batteries in series and parallel. The system design has considered the occurrence of hazards or failures. But their absolute safety cannot be guaranteed.

In the event of leakage of material inside the product, the user should implement the following recommendations.

- (1) If inhaled, leave contaminated area and seek medical attention immediately.
- (2) In case of contact with eyes, flush eyes with running water for 15 minutes and seek medical attention immediately.
- (3) In case of contact with skin, wash contact area thoroughly with soap and seek medical attention immediately.
- (4) If swallowed, induce vomiting and seek medical attention.

#### Fire occurs

If the battery is found to be on fire, first cut off the battery cluster circuit breaker and shut down the system connection when it is safe to do so.

Immediately evacuate people and contact the local fire department.

The battery system uses FM-200 or Co2 fire extinguishers, and the rest of the system uses ABC fire extinguishers.

## 9 Power Station Fault Handling and Emergency Plan

### 9.1 Power station fault handling

#### 1) Failure cause analysis and tracking

1. The operation and maintenance personnel check the cause of the fault and whether it is an important emergency fault (such as fire alarm, insulation fault, BMS tripping fault, overcurrent protection fault, etc.). The operation and maintenance personnel should immediately go to the site to deal with it. If it cannot be dealt with quickly, please arrange personnel from the nearest unit to go to the energy storage power station to confirm whether it is safe.

2. After the operation and maintenance personnel arrive at the site to check, the PCS will be restarted after the general fault is eliminated.

Contact the operation and maintenance engineer of Sunnygrow in time for the fault that cannot be eliminated.

3. If our company's remote assistance still cannot solve the problem, our company will send relevant personnel to the scene to deal with it as soon as possible.

4. Emergency handling method of fault accident: If the system is abnormal, first of all, it is necessary to find out the problem (such as BMS failure, PCS failure, EMS failure, etc.) through background data and SOE event records,

etc. If the BMS fails, you can follow the following common BMS troubleshooting solutions:

A) Common first-level and second-level alarms such as voltage, temperature, and differential pressure that do not affect the normal operation of the strategy can be ignored. These alarms are pre-alarms generated during system operation;

B) When the system fails and cannot operate normally, the first thing to do is to find out the cause of the failure. First, check the background monitoring to confirm which group of battery systems, and then check the alarm records on the human machine interface display in the container, or check the BMS alarm records in the background to accurately locate the fault;

C) Slave control communication troubleshooting solution: Check whether the slave control communication harness with the words BMU\_CAN on the terminal block of the high-voltage box is connected well, whether the terminal block screws are loose, check whether the slave control communication line plugged into the battery box is plugged in well, and whether the pins on the wiring harness connector are securely connected;

D) Master control communication failure solution: check whether the power supply of the high-voltage box is normal, and whether the indicator light of the high-voltage box is normal, check whether the connection of the wiring harness on the terminal row of the high-voltage box is loose, whether the screws are locked, etc.;

E) Solution for communication failure between BMS and PCS: Check whether the power supply of the first cluster of high-voltage boxes is normal, and whether the RS485 connection line for communication with the PCS on the terminal block of the high-voltage box is well connected;

F) Solution for PCS communication failure: Contact PCS manufacturer for corresponding treatment;

G) Troubleshooting solution for communication between BMS and background: Check whether the power supply of the IEC61850 protocol converter in the BMS cabinet is working properly, whether the connection line between the BMS and the COM port of the protocol converter is normal, whether the data light of the conversion COM port is flashing normally, check whether the connection of the network cable to the LAN port is loose, and whether the data light of the LAN port flashes normally;

H) Solution for battery cluster failure to connect to the grid: Check whether the battery cluster that fails to connect to the grid has an alarm that affects the operation of the strategy, and check the difference between the total voltage of the battery cluster that fails to connect to the grid and other clusters. If the difference is too large, the battery cluster need to be balanced for charge and discharge processing.

I) Three-level alarms such as overvoltage and undervoltage of the battery pack exist, and the protection contactor at the battery pack end cannot be closed normally solution: Modify the three-level protection parameter value through the man-machine interface to temporarily restore the system to normal. When the battery pack is charged or discharged to the normal range, the protection parameter is set back to the default value;

J) Solution for BMS system failing to supply power normally: Check whether the power supply of the distribution box is normal, check whether the UPS system works normally, and check whether the working status of the isolation transformer is normal;

K) The battery pack was successfully connected to the grid, a certain cluster in this group has no charging and discharging current when charging and discharging solution: Check whether the main circuit isolating switch is closed, and check whether the fuse in the high-voltage box is damaged.

### 2) Troubleshooting

Table 1. Battery system failures and solutions

No.	Fault description	Solution
2	Battery pack temperature is too high	Stop charging and discharging, and resume charging and discharging after returning to normal temperature.
3	Insulation failure	Stop charging and discharging for maintenance.
4	The internal resistance of the battery cell is too large	Perform maintenance and charging first. If the internal resistance is still too large, contact the manufacturer to replace the battery.
5	The battery capacity difference is too large	Perform maintenance and charging first. If the capacity difference is still too large, contact the manufacturer to replace the battery.
6	Battery short circuit	Contact the factory to replace the battery.
7	Excessive capacity decay	Contact the factory to replace the battery.

Table 2. Fire fighting system failures and solutions

Problem type	Problem	Possible reason	Solution
Fire alarm display	Fire alarm graphic display sound and light alarm test no response	Sound and light alarm USB interface loose	Replug the USB port
	Fire alarm graphic display sound and light alarm high line		
	The fault indicator is yellow	Fire fighting host communication failure	Check whether the fire fighting host network cable is plugged in properly
		Fire fighting host UPS feed	The corresponding fire host is powered on and charged
Other faults		Make a repair call	
Fire fighting host	The system cannot start	DIP switch is set to download mode	Set the DIP switch to start mode
	UPS cannot supply power normally	The backup power switch in the box is not closed	Close the backup power switch
Emergency start-stop switch	Manual/Auto cannot be switched	System works abnormally	Make a repair call

### 9.2 Power station emergency plan

In order to ensure that the safe production of energy storage power stations is implemented, and conscientiously implement the "Safety Production Law", "Electricity Safety Work Regulations" and "Electricity Law" and other laws, regulations and standards, according to relevant policies and regulations and combined with the actual situation of the power station, formulate corresponding emergency plans. The purpose of formulating emergency plans is to quickly, orderly and efficiently control the development of emergencies and minimize accident losses.

According to the operation characteristics of the energy storage power station, the possible safety accidents of the power station include equipment fire accidents and personal electric shock casualties. The manpower, material and technical preparation of the emergency plan are mainly aimed at these two types of accidents.

#### 1) Emergency plan for fire accident of power station equipment

In the event of an equipment fire emergency, the power station should immediately cut off the power switches and knife switches on all sides of the electrical equipment, power off the fire equipment, and quickly organize personnel to carry out automatic fire extinguishing of the container, and report to the duty person in charge of the power station and the dispatcher at the same time. The person in charge of the power station on duty called the fire police while organizing personnel to check and put out the fire at the scene, asking the local fire department for support, explaining that the electrical equipment was on fire, and requiring a dry powder or foam fire-fighting team.

After the fire control center called the public security fire 119, it immediately turned on the emergency broadcasting and fire alarm bells on the relevant floors of the fire floor, and notified the relevant floor personnel to evacuate in an orderly manner under the command of the on-site staff. Try not to cause panic among the on-site people, and remind on-site personnel to pay attention to preventing smoke inhalation.

The fire control center cuts off the non-fire-fighting power supply in the fire area according to the command instructions, maintains contact with the on-site staff, and turns on equipment such as fire pumps, sprinkler pumps, fire shutters and other equipment according to the on-site conditions; It is strictly forbidden to open the device at will when it is not needed or not allowed on site.

After the fire brigade arrived at the scene, the fire control center personnel reported the fire situation to the fire brigade in time and assisted in fighting the fire.

2) Personal electric shock casualty emergency plan in the event of a personal electric shock emergency, the first insider at the scene must remain calm, and take emergency rescue measures correctly when conditions permit. First of all, implement on-site first aid for the injured person to keep the victim out of danger, and at the same time report to the company's emergency response organization. The company's emergency plan organization should respond as quickly as possible.

The power station management personnel maintain the order of the accident scene, isolate and evacuate the scene according to the situation, take corresponding measures for the rescue team to carry out on-site rescue, transfer the injured personnel to perform on-site first aid, and escort the injured to hospital for treatment. Under the guidance and organization of the on-site commander, the source of danger that causes personal injury should be properly handled to prevent the injury from continuing.

Remarks: In order to continuously improve customer satisfaction, the company's products and product manuals are in continuous improvement and upgrading. If there is a difference between the manual in your hand and the product, it may be due to the version, please refer to the specific product. If you still have questions, please contact our company.